

L-Cube

LC 5854

Montážní návod

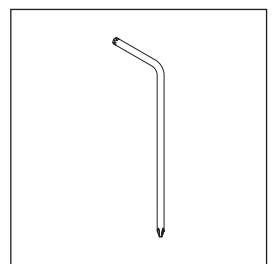
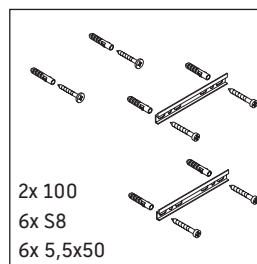
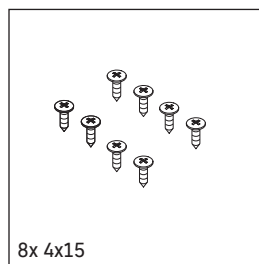
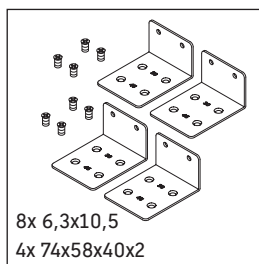
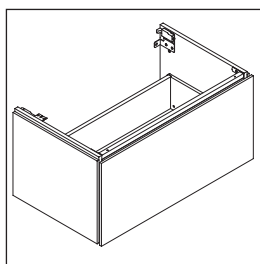
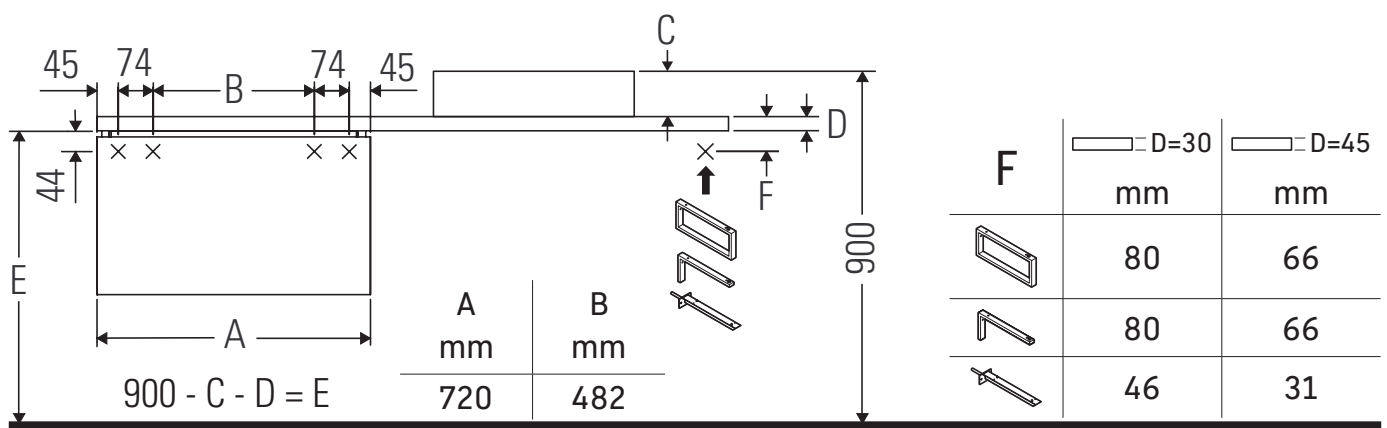

Dodržujte rozměry vrtaných otvorů!



Dodržujte všechny další návody k montáži!

Pokyny k použití

Tato řada koupelnového nábytku splňuje normy a směrnice platné k datu expedice a byla navržena pro použití v koupelnách. Nábytek nesmí být přímo smáčen vodou, např. při sprchování.

Sanitární keramiky širší než 600 mm se musí připevnit ke stěně.

Vyhrazujeme si technická zlepšení a optické změny zobrazených výrobků.

